

DS-2TP23-10VM/W Handheld Thermography Camera



The handheld thermography camera, specially designed for temperature measurement in transformer substation. It's equipped with a 384×288 resolution thermal detector and a 5MP resolution optical light detector. The 3.5-inch touch screen displays picture in picture of optical and thermal view, fusion of both channels. It helps the staff to quickly find the fault according to accurate temperature measurement of high temperature targets in the environment. Meanwhile it provides assistant decision and ensure safety.

Key Features

- 384 × 288 resolution (thermal), and 1080P resolution (optical)
- DDE (Digital Detail Enhancement) technique
- 3D DNR, adaptive AGC (Automatic Gain Control)
- 640×480 resolution 3.5" LCD touch display
- Built-in rechargeable Li-ion battery
- Up to four hours continuous running



Application Scenarios

The device is mainly applied to various industries, such as Power, Photovoltaic, Metallurgy, Piping, Building, Electronics, Telecommunication, Fire control, and Data center, etc.,



Power



Photovoltaic



Metallurgy



Piping



Building



Electronics



Telecommunication



Fire Control



Data Center

Functions

Thermography

Device detects the real-time temperature, and display it on the screen.

Storage

Device is equipped with built-in memory module to store recorded videos, captured snapshots, and important data.

Fusion

Device can display fusion of thermal view and optical view.

Palette and Alarm

Device supports multiple palettes, and you can set the palette mode according to the alarm function

Wi-Fi Function

Device can be connected to Wi-Fi. You can connect the device via Wi-Fi hot spot, and you can view live view, capture, and recording, etc.

Digital Zoom

Device supports 1×, 2× and 4× digital zoom.

LED Light:

LED light supplement makes the device a torch in required scenarios.

Laser Light Supplement:

Long-distance laser light supplement to point the thermography target.

Specifications

		Model	DS-2TP23-10VM/W
Parameter			Handheld Thermography Camera
Thermal Module	Image sensor	Uncooled Focal Plane Arrays	
	Max. Resolution	25Hz: 384 × 288	
	Pixel Pitch	17μm	
	Response waveband	8μm to 14μm	
	NETD	< 40mk (@ 25 °C, F#=1.0)	
	Field of View	37.5 ° × 28.5 °	
	Focal length	10 mm (Manual focus)	
	IFOV (mrad)	1.7mrad	
Optical Module	Aperture	F 1.0	
	Max. Resolution	1920 × 1080	
	Picture Resolution	Display: 384*288; Capture: 1920 × 1080	
Image Display	Video Resolution	Display: 384*288; Record:1920 × 1080	
	Monitor	640 × 480 resolution 3.5'' LCD touch display	
	Palettes	Black hot, White hot, Red hot, Rainbow, Ironbow, Fusion, Rain	
	Digital Zoom	Thermal: 1×, 2×, 4×	
	Thermal / Optical	Thermal/Optical/Fusion image/Picture in picture	
	Picture in Picture	Support Thermal View in Optical View	
	Fusion	Support (Thermal View and Optical View Combined)	
Thermography	Record Video	Support on-board video recording	
	Rules	Max. Temperature; Min. Temperature; Center Temperature; Custom Point/Line/Area Thermometry	
	Thermometry Range	-20 °C to 550 °C (-4 °F to 1022 °F)	
Battery	Thermometry Accuracy	Max (±2 °C, ±2%)	
	Battery Type	dismountable and rechargeable Li-ion Battery	
Functions	Battery Operating Time	Four hours continuous running	
	Laser Light	Support (Point to the thermography target)	
	Storage	Built-in memory module (64G)	
	Photo	Thermal/Optical/Fusion image	
	Video	Thermal/Optical/Fusion image	
	Lighting	Support	
	Wi-Fi	Support	
	Text Comment	Support	
	Voice Comment	Support	
General	Language	English	
	Power	12 V DC/1.5A, 5V DC/2A (Charging via USB)	
	Power Consumption	Approx. 5 W (Wi-Fi On), 4.2 W (Wi-Fi Off)	
	Hardware Interface	micro USB	
	Working Temperature	-20 °C to 50 °C (-4 °F to 122 °F)	
	Protection level	IP54	
	Drop Test Height	2 m (6.56 feet)	
	Dimension	244 mm × 100 mm × 104 mm (9.6 " × 3.9 " × 4.1 ")	
Weight	Approx. 660 g (1.46 lb)		

Order Models

DS-2TP23-10VM/W

Box Content

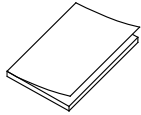

User Manual (x1)

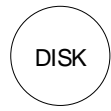

Disk (x1)

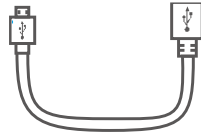

USB Cable (x1)



power Adapter
(x1)

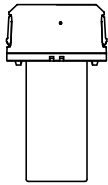

Battery (x1)

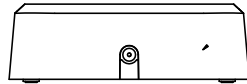

Charging Base (x1)

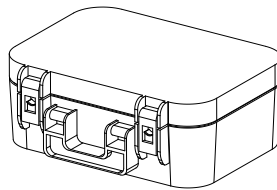

Box (x1)

Dimensions

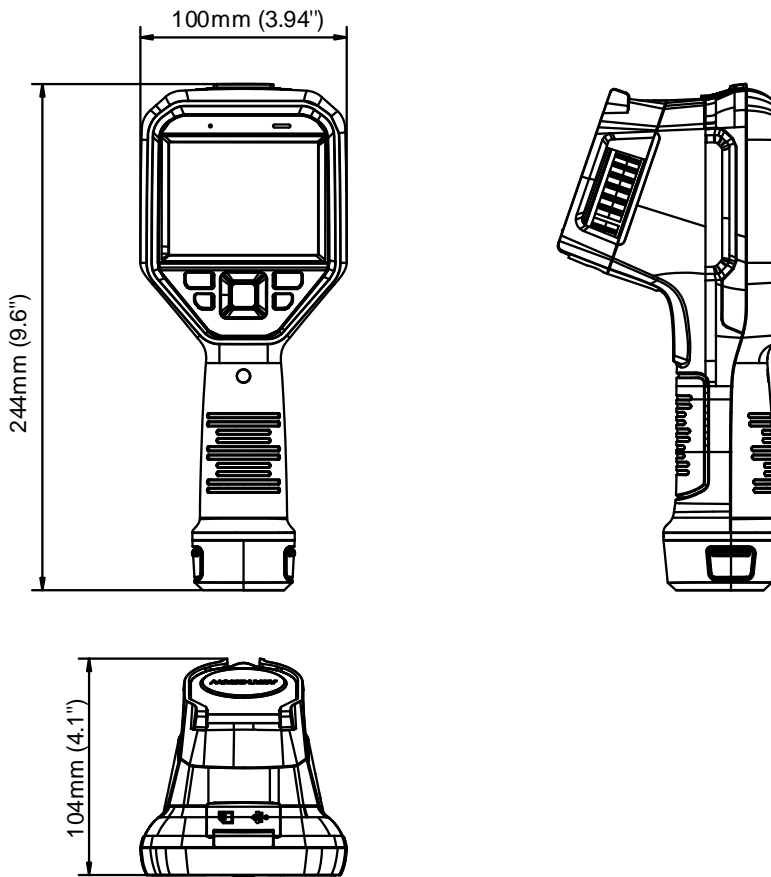

Distributed by



HIKVISION®

Headquarters

No.555 Dianmo Road, Binjiang District,
Hangzhou 310051, China
T +86-571-8807-5998
overseasbusiness@hikvision.com

Hikvision USA
T +1-909-895-0400
sales.usa@hikvision.com

Hikvision Europe
T +31-23-55-42-770
info.eu@hikvision.com

Hikvision Middle East
T +971-4-8816086
salesme@hikvision.com

Hikvision Russia
T +7-495-669-67-99
saleru@hikvision.com

Hikvision India
T +91-22-28469900
sales@pramahikvision.com

Hikvision Italy
T +39-0438-6902
info.it@hikvision.com

Hikvision France
T +33(0)1-85-330-450
info.fr@hikvision.com

Hikvision Spain
T +34-91-737-16-55
info.es@hikvision.com

Hikvision Poland
T +48-22-460-01-50
poland@hikvision.com

Hikvision UK
T +01628-902140
support.uk@hikvision.com

Hikvision Singapore
T +65-6684-4718
sg@hikvision.com

Hikvision Oceania
T +61-2-8599-4233
salesau@hikvision.com

Hikvision Canada
T +1-909-895-0400
sales.usa@hikvision.com

Hikvision Korea
T +82-31-731-8841
sales.korea@hikvision.com

Hikvision Brazil
T +55 11 3318-0050
Latam.support@hikvision.com

Hikvision Africa
T +27 (10) 0351172
sale.africa@hikvision.com

Hikvision Hong Kong
T +852-2151-1761